

ARES

User Manual



✓ Note:

- Before using the product, please read these instructions carefully, and kept safely for future reference.
- OSD options and pictures shown in this document may differ slightly from your product..
- Changes to this manual may be made without notice.

Introduction to the Projector

This section introduces you to your new projector and describes the features and controls.

- **Support High Resolution Signal**

The projector has the Multi-scan system to conform to many output signals. Up to 4096X2160@60Hz (HDMI).

- **Useful Functions for Presentations**

The digital zoom function allows you to focus on the crucial information during a presentation.

- **Light source**

- **Brightness**

- A long-life laser diode is equipped in the light module. The product can be operated at low cost because the laser light source can be used for a long time without replacement or maintenance.

- Brightness can be adjusted.

Unlike with ordinary light source, the brightness can be adjusted from 50 to 100% when Normal mode.

- **Convenient Maintenance Functions**

Filter maintenance functions provide for better and proper maintenance of the projector.

- **Multiple viewing modes**

Supports multiple viewing modes including Standard, Soft, Movie, Sport, Game, and User, and can be selected based on the actual video content watched.

About this user's manual

The fastest way to get started is to take your time and do everything right the first time. Take a few minutes now to review the user's manual. This may save you time later on. At the beginning of each section of the manual you'll find an overview. If the section doesn't apply, you can skip it.

Model	Model name	Brightness (Marketing)	Resolution	wAspect ratio
Standard	ARES-7K	7,000lm	4K Enhancement (3840× 2160 pixels)	16:10(Native) 4:3/ 16:9(Compatible)
	ARES-8K	8,000lm		









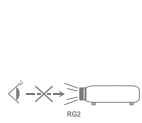

- Before using the product, please read these instructions carefully, and kept safely for future reference.
 - OSD options and pictures shown in this document may differ slightly from your product.
 - Changes to this manual may be made without notice.
-

Safety operation guideline

Safety instruction

This document and your projector employ certain symbols to illustrate how to use your projector safely. Please get yourself familiar with them before going through this document.





	Caution	Ignoring messages indicated by this symbol may lead to personal injuries or deaths due to human errors.
	Note	Ignoring messages indicated by this symbol may lead to personal injuries or property damage.
		High voltage inside with risks of electric shock.
		<ul style="list-style-type: none"> Do not look into the projector's lens. Do not look at the projected light using optical devices (magnifying glasses, reflectors, etc.). Doing so could result in vision impairment. Check that there is no one looking at the lens within the projection range before turning on the projector. Do not allow children to operate the projector alone. When a child is operating the projector an adult should always be present and watch the child carefully.
  		Do not place objects in front of the lens while the projector is operating.

	Caution Danger of electric shock! DO NOT open this.	
<p>Note: DO NOT remove the casing (or back cover) as this may result in electric shock. Users shall not execute any maintenance work on components within your projector. Call qualified maintenance personnel in case of any maintenance requirements.</p>		





 High voltage inside with risks of electric shock.

 Operation and maintenance tips about these components.

Examples of symbols

	This symbol indicates you should be careful of electric shocks.
	This symbol indicates you should be careful of high temperatures.
	This symbol indicates something that must be prohibited.
	This symbol indicates something that must not be got wet.

Safety operation guideline

	This symbol indicates you should not touch with wet hands.
	This symbol indicates something that must not be disassembled.
	This symbol indicates things you must do.
	This symbol indicates that the power cord should be unplugged from the power outlet.

Warning:

DO NOT leave the projector in the rain or expose it to moisture environment to prevent fire or electric shock.

The proposed plug should not be used in an extension cord outlet or other outlet unless the pin is fully plugged in.



Warning:

Installing the projector

This projector is an RG2 product. The projector is for professional use and must be installed in location where safety is assured. For this reason, be sure to consult your dealer as installation and attachment/detachment of the lens unit must be performed by a professional service personnel. Never try to install the projector by yourself. This may result in visual impairment etc.



CAUTION:

Avoid displaying stationary images for a prolonged period of time.

Doing so can result in these images being temporarily sustained on the surface of the LCD panel.

If this should happen, continue to use your projector. The static background from previous images will disappear.

Safety operation guideline

Disposing of your used product



In the European Union

EU-wide legislation as implemented in each Member State requires that used electrical and electronic products carrying the mark (left) must be disposed of separately from normal household waste. This includes projectors and their electrical accessories. When you dispose of such products, please follow the guidance of your local authority and/or ask the shop where you purchased the product.

After collecting the used products, they are reused and recycled in a proper way. This effort will help us reduce the wastes as well as the negative impact to the human health and the environment at the minimum level.

The mark on the electrical and electronic products only applies to the current European Union Member States.

Outside the European Union

If you wish to dispose of used electrical and electronic products outside the European union, please contact your local authority and ask for the correct method of disposal.



For EU:

The crossed-out wheeled bin implies that used batteries should not be put to the general household waste! There is a separate collection system for used batteries, to allow proper treatment and recycling in accordance with legislation.

According the EU directive 2006/66/EC, the battery can't be disposed improperly. The battery shall be separated to collect by local service.

Warning:

This equipment is compliant with Class A of CISPR 32. In a residential environment this equipment may cause radio interference.

Please read this manual carefully before installing and operating your projector

Your projector comes with a lot of convenient features and functions. You may make the most of these features and keep your projector in good working conditions by using it correctly. Invalid operation of your projector may not only shorten its life cycle but also may lead to product failure, fire, or other incidents.

In case of any operation abnormality, refer to this manual to check your operation and connections and try solutions given in the "Troubleshooting" section at end of this manual. If the problem persists, call your dealer or our service center.

Notes



Caution

Safety precautions:

- GROUND your projector.
- Lens of your projector projects strong light. DO NOT look at the light beam directly. You may get your eyesight hurt. This is especially the case with children.
- Unplug the AC power plug if your projector will not be used for long time.
- DO NOT overload the socket of power cord as it may lead to fire or electric shock. DO NOT subject the power cord to any object. DO NOT place your projector in locations where its power cord may become damaged by treading by passersby.
- Disconnect the power plug before cleaning your projector. DO NOT apply liquid or sprays to your projector. DO NOT wipe your projector with wet cloth.
- Please follow warnings and instructions given in labels attached to your projector. Unplug your projector when your projector is exposed to thunderstorm weather, is unmanned, or not in use for long periods to prevent damage caused by lightning and power surges.
- DO NOT use accessories without recommendation by the manufacturer as it may result in potential risks.



Caution

Precautions on air outlet:

- Keep adequate clearance around your projector for its ventilation and cooling. See figure below for the least clearance requirements. The least clearance is a MUST when your projector is placed within a cabinet or other closed environment.

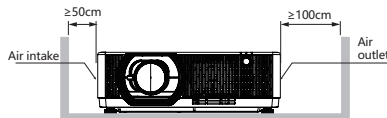

- DO NOT cover the air outlet of your projector. Poor ventilation not only shorten life cycle of your projector but also may lead to risks.
- Slots and openings at rear and bottom of your projector are designed for ventilation. Keep your projector from overheated to ensure its steady operation.
- DO NOT cover the air outlet with cloth or other objects. DO NOT place your projector on the surface of bed, sofa, carpets, or similar object as this may block the air outlets at its bottom.
- DO NOT place your projector in closed environment, e.g. a bookcase, unless it is well ventilated.
- Keep any matter from falling in your projector through the air outlets as they may touch high voltage parts and lead to fire or electric shock by short circuits. DO NOT splash liquid to your projector.

Safety operation guideline



Note

Precautions on location of your projector:

- Place your projector in a proper location or it may result in fire.
- DO NOT expose your projector in rain or high humidity environments or it may result in fire or electric shock. DO NOT place your projector near water or splashing water. DO NOT place any water container, e.g. flower vase, atop your projector.
- DO NOT place your projector in environments of soot, moisture or smoke, e.g. your kitchen, or it may lead to product failure or accidents. Your projector may be damaged by contact with oil or chemicals.
- DO NOT place your projector near exhaust pipe or air conditioning equipment.
- DO NOT place your projector near radiator or heating pipes.
- DO NOT place your projector atop unstable truck, rack, or table. It may fall off the surface and lead to personal injuries and property damages. Please use cart or rack recommended by the manufacturer or included with your product. Please follow steps given in installation guideline included with the wall and ceiling mount racks for installation. Use installation components approved by the manufacturer.
- Be careful when moving your projector with cart. Abrupt stops, pushing too hard and rugged surfaces may topple your projector and the cart together.



Note

Precautions on using your projector:

- DO NOT project the same image for long time as residual images may be left in the panel. This is a property of LCD panel.
- Use power as indicated in tags attached to your projector. If you have doubts over available power type, consult your dealer or local power company first.
- DO NOT open or remove the casing for maintenance as this may lead to electric shock or other damages.
 - Call qualified maintenance personnel in case of any maintenance requirements. In case of the following, unplug the power cord and call qualified maintenance personnel for service immediately:
 1. a. Damaged or broken power cord or plug
 2. b. Liquid splashed in your projector
 3. c. Your projector exposed to rain or water
 4. d. If your projector fails to work as expected by following operation instructions, adjust it according to given instructions. Other invalid operations may damage your projector, which requires the technician to spend more time before returning it back to normal.
 5. e. The projector falls off to ground or its casing is damaged.
 6. f. In case of any abnormal change in your projector during its use, then maintenance services would be required.
- In case components replacement is required, make sure the replacements have been approved by the manufacturer and features the same with the one being replaced. Use of unauthorized parts may lead to fire, electric shock or personal injury.
- After the completion of maintenance or repair work, get the maintenance personnel to run routine safety check to ensure your projector's safety operation status.

Information for users in the European Union

This is a device to project images onto a screen, etc., and is not intended for use as indoor lighting in a domestic environment.

Directive 2009/125/EC.



Note

[Please heed all precaution for safety Precautions on using your projector:](#)

To install the projector

- This projector is an RG3 product. The projector is for professional use and must be installed in location where safety is assured. For this reason, be sure to consult your dealer as installation and attachment/detachment of the lens unit must be performed by a professional service personnel. Never try to install the projector by yourself. This may result in visual impairment etc.
- For planning the layout of the projector, make sure to take safety measures instructed on the installation manual.
- In order to refuse danger, install either a wall outlet within easy reach for pulling out the power plug in emergency or a device as a breaker to shut down the power supply to the projector.
- Take safety measures preventing human eyes from entering the RG3 zone.
- Considering the installation place, select an appropriate lens and secure safety zone that is determined for each
- lens. For operation on the powered projector as light adjustment, make sure appropriate safety measures have been taken.
- Check the validity of taken security measures if appropriate safety zone based on the installed lens is secured.
Periodically check the validity and keep these results.
- Educate the administrator of the projector (operators) about safety before starting to operate the projector.

To use the projector

- Instruct the administrator of the projector (operators) to perform inspections before powering on the projector. (Including the safety check against emitted light by the projector)
- Instruct the administrator of the projector (operators) to be in circumstances able to control the projector whenever the projector is powered on for an emergency.
- Instruct the administrator of the projector (operators) to keep the installation manual, user's manual and inspection records to a place where they can take these documents out easily.
- Instruct them to clarify if the projector is conformed to standards of each country and region.

Air ventilation

Openings in the casing are designed for ventilation and overheating prevention. DO NOT block or cover these openings to keep your projector in normal operation and from overheating.



Note

Heat exhaust at the air outlet Keep the following in mind when using or installing your projector:

- DO NOT place flammable materials or sprayers near your projector.
- Keep the air outlet one meter away from other objects.
- DO NOT touch the area close to the air outlet especially the metal components, e.g. screws. This area and parts will get very hot once your projector starts operating.
- DO NOT place any object atop your projector. They may not only be damaged but also lead to fire after being overheated.
- Cooling fans are designed for cooling your projector. Fan speed is auto adjusted subject to internal temperature of your projector.

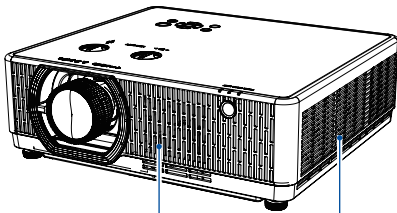

Air intake
(For heat intake)

Air outlet
(For heat exhaust)

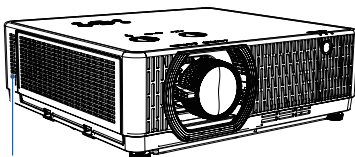

Air intake
(For heat intake)

Place your projector correctly

Use your projector at specified location in correct way. Invalid projector location may shorten light source 's life-cycle or even lead to severe incidents or fire.

360° projection

Our projector support 360° projection.

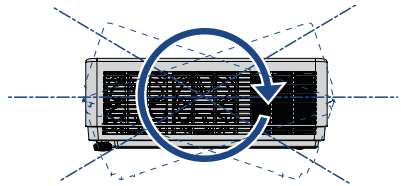

Vertical 360°

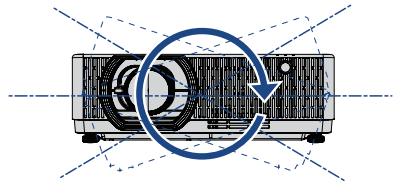

Horizontal 360°

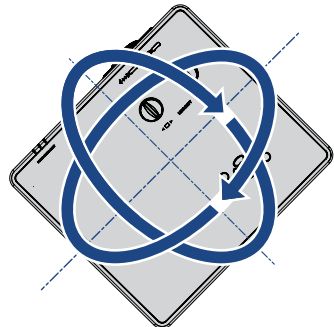

Vertical & Horizontal 360°

Safety operation guideline



Note

- Precautions on ceiling mount racket installation:
- Get qualified technician to install the ceiling mount racket.
- Warranty of your projector does not cover hazards and damage caused by using ceiling mount rackets provided by unauthorized dealers.
- Remove the ceiling mount racket when it is not in use.
- Apply torque driver instead of impact driver in your projector.

Moving your projector

When moving your projector, close its adjustment legs as they may damage the lens and casing. Keep your projector in suitable box when it is not to be used for a long time.



Note

- Precautions on moving or shipping your projector:
- DO NOT drop or impact your projector as it may get damaged or failed in operation.
- Please employ proper container for movement.
- Prohibit express or other shipping service provider personnel from shipping your projector with improper boxes. Your projector may become damaged. Please consult your dealers for shipping your projector by express or other shipping service providers.
- Place your projector in box only after it has been fully cooled down.

FCC Caution

This equipment has been tested and found to comply with the limits for a Class A digital device, pursuant to Part 15 of the FCC Rules. These limits are designed to provide reasonable protection against harmful interference when the equipment is operated in a commercial environment. This equipment generates, uses, and can radiate radio frequency energy and, if not installed and used in accordance with the instruction manual, may cause harmful interference to radio communications. Operation of this equipment in a residential area is likely to cause harmful interference in which case the user will be required to correct the interference at his own expense.

Notice Concerning Electromagnetic Interference (EMI)

Operation of this equipment in a residential environment could cause radio interference.



Note

- Connect the equipment to a socket-outlet with earthing connection by means of a power cord.
- The socket-outlet shall be installed near the equipment and shall be easily accessible.

Accessory

Accessory as follows:

The projector includes such following accessories. Please check all the packaging. If any items are missing, please contact your dealer immediately.

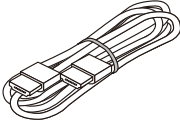
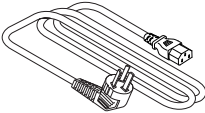
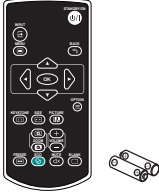
HDMI cable	Power cord	Remote Control (Including Batteries) (AAA *2)
		

Name and function of your projector

Front/Top

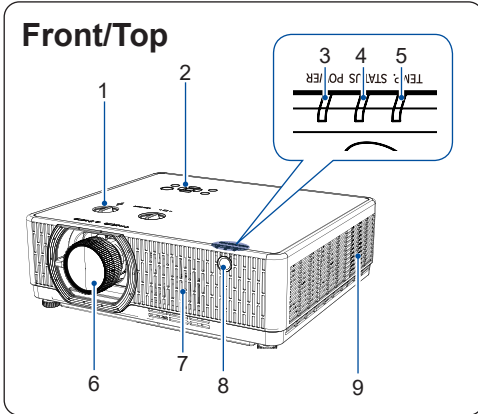

- 1 Lens shift
- 2 Keypad
- 3 Power indicator
- 4 STATUS indicator
- 5 TEMP indicator
- 6 Projection lens
- 7 Air intake grille
- 8 Remote Receiver (FRONT)
- 9 Air outlet grille

Side

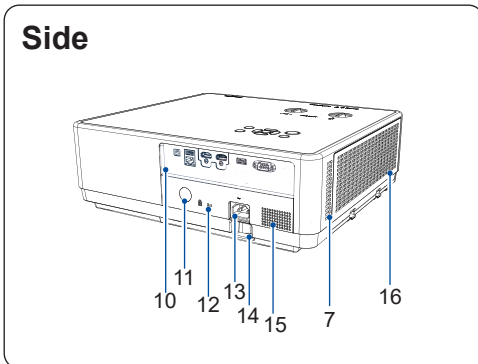

- 10 Terminal
- 11 Remote Receiver (BACK)
- 12 Security hole
- 13 AC power cord port
- 14 Security chain opening
 - Attach an anti-theft device.
 - The security chain opening accepts security wires or chains up to 0.18 inch/4.6 mm in diameter.
- 15 Speaker
- 16 Filter

Bottom

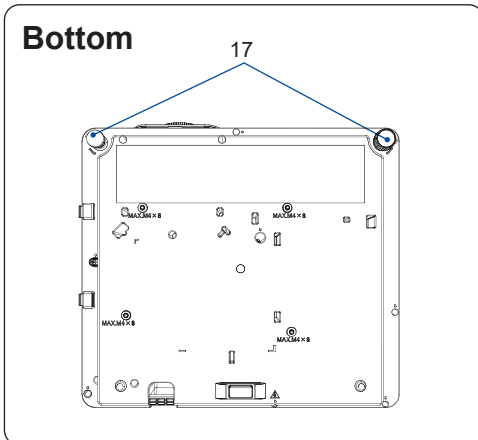

- 17 Adjustment pad

Note

Donot place your hands or other objects near the vent:

- Vent will shed heat. Do not put your hands or face, or thermolabile objects placed near the outlet . you need keep at least a distance of 3"(1m) away, or it may cause it burning or damage.

Name and function of your projector

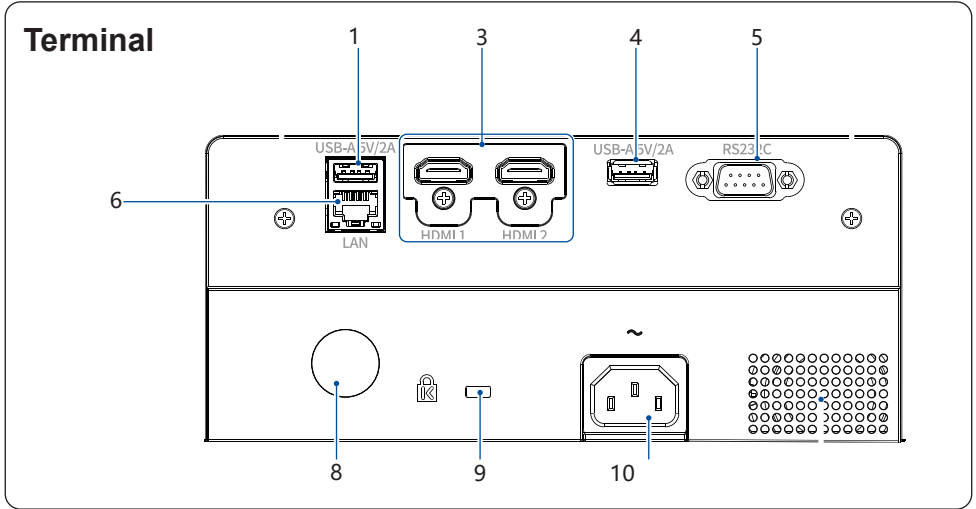

Terminal

1. USB-A connector
 - In addition, a 5V/2A power supply can be supplied for expansion use.
3. HDMI1/HDMI2 connector
 - Connect HDMI digital output signals or HDMI2 digital output signals to this terminal.
4. USB-A connector
 - In addition, a 5V/2A power supply can be supplied for expansion use.
5. RS-232C
 - Select the RS232 function to operate the projector, connect the serial communication to this terminal.
6. LAN terminal
 - Connect mesh cable to this terminal when using network control and operate your projector.
8. Remote Receiver(Rear)
 - Use the remote control to operate the projector.
9. Security slot
 - This terminal is used to prevent projector theft.
10. AC power cord terminal
 - Connect the supplied power cord's three-pin plug here, and plug the other end into an active wall outlet.

Name and function of your projector

Top control panel and indicators

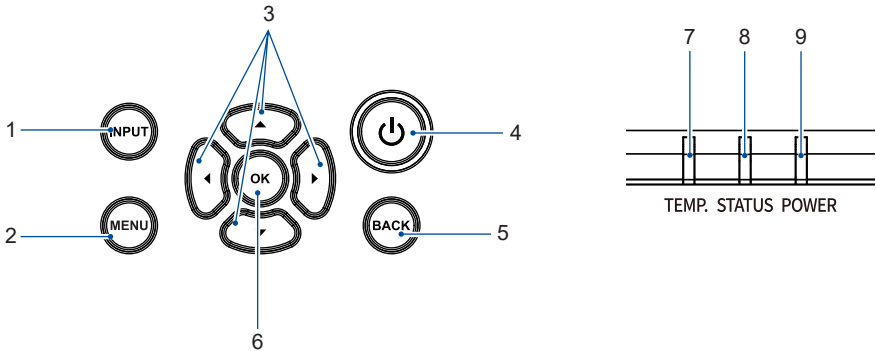

1 INPUT

Open or close the input menu.

2 MENU

Open or close the OSD menu.

3 Arrow ▲ ▼ ◀ ▶ /Volume +/- /Keystone ▼

- Select items or adjust the data in the OSD menu.
- It uses to adjust volume or make keystone adjustment.
- It uses to enter password.

4 POWER

Open or close the projector.

5 EXIT

Exit the menu screen.

6 ENTER

- Enter the OSD menu
- Select options in the OSD menu.

7 POWER indicator

This indicator informs the power status of the projector

8 STATUS indicator

Lights up/flashes when a button is pressed with the [CONTROL PANEL LOCK] enabled, or when an error occurs in the projector.

9 LIGHT indicator

This indicator informs the state of light source, used time of the light source.

Name and function of your projector

Remote control

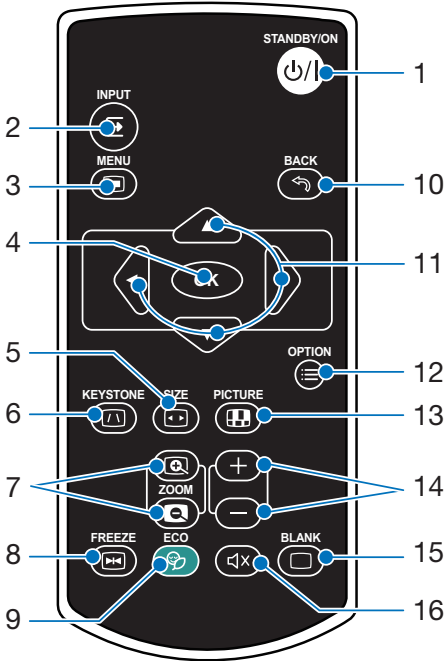

1.<STANDBY/ON>button
Turn on or off the projector.

2.<INPUT>button
Used to switch input modes.

3.<MENU>button
Enter the menu interface.

4.<OK>button
Used to set the selected or adjusted items on the menu.

5.<SIZE>Button
Used to switch screen size.

6.<KEYSTONE>button
Used for entering trapezoidal correction mode.

7.<ZOOM (+/-)>button
Used to enlarge/reduce a certain part of an image.

8.<FREEZE>button
Used to make the image still.

9.<ECO>button
Used to reduce cooling fan noise.

10.<BACK>button
Exit the menu screen.

11.<▲/▼/◀/▶> button
Used to select and adjust menu items.

12. <OPTION>button
Used to edit files or set the way files are displayed/arranged on a USB channel.

13.<PICTURE>button
Used to select the appropriate image.

14.NOT USED

15.<BLANK>Button
Temporarily showing a black screen.

16. NOT USED

Name and function of your projector

Remote control operation range

Point your remote control to the IR receiver of your projector.

Maximum operation range of your remote control is about arc 30° and with about an area of radius 6 meters or about 8 meters in straight line.

The projector will not respond if there are objects between the remote control and the sensor, or if strong light falls on the sensor. Weak batteries will also prevent the remote control from properly operating the projector.

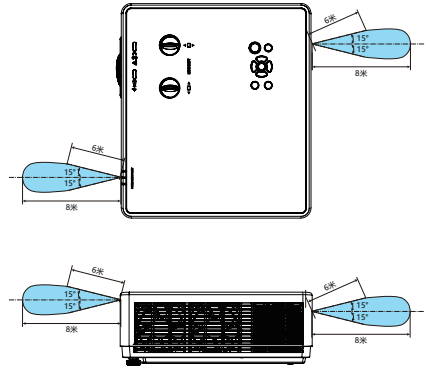

Install battery of remote control

1 Open the battery cover.

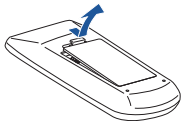

2 Insert a new battery in it.

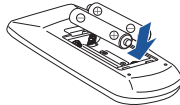

Two AAA batteries
Place batteries with its anode and cathode (+ and -) in correct direction. Keep both poles in good connection to the contacts within the compartment.

3 Put the cover back.



Please follow the following rules for safety operation:

- Use two of AAA batteries.
- Replace both batteries at the same time.
- Do not mix new and old batteries as one pair.
- Keep your remote control away from water or other liquids.
- Do not expose your remote control to environments with high humidity or temperature.
- Do not drop your remote control.
- In case of any battery solution leaking in the compartment, clear it thoroughly before placing new batteries in it.
- Using battery of other types than what specified on this manual may lead to risks of explosion.
- Please dispose your old battery by following instructions given in tag of the battery or local regulations.

Installation

Screen size

- Ambient brightness may affect your projection image quality. For the optimal image effect, it is recommended to control brightness in your environment.
- Values shown in figure below are approximates only. They may differ from the actual ones.
- The further the projector is away from the screen, the larger the projection size will be.
- Use the following table to install the projector in the best position from the screen. The values provided are for reference only.

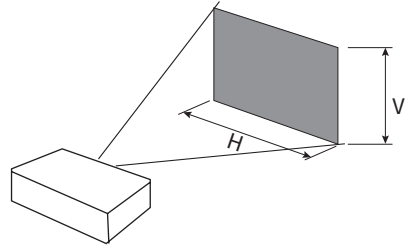
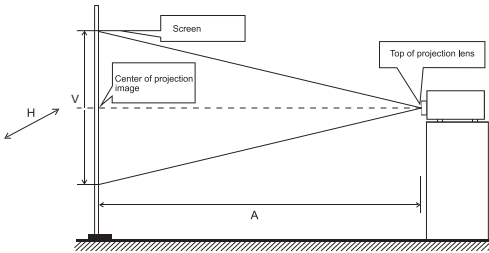

16:9 Perspective				
Screen Size	Width(H)	Height(V)	Wide	Tele
30	0.664	0.374	0.786	1.293
40	0.886	0.498	1.060	1.736
60	1.328	0.747	1.608	2.621
70	1.550	0.872	1.882	3.064
80	1.771	0.996	2.156	3.506
90	1.992	1.121	2.430	3.949
100	2.214	1.245	2.704	4.392
120	2.657	1.494	3.252	5.277
150	3.321	1.868	4.075	6.605
180	3.985	2.241	4.897	7.933
200	4.428	2.491	5.445	8.818
250	5.535	3.113	6.815	11.031
300	6.641	3.736	8.186	13.244

16:10 Perspective				
Screen Size	Width(H)	Height(V)	Wide	Tele
30	0.646	0.404	0.992	1.626
40	0.862	0.538	1.335	2.180
60	1.292	0.808	2.020	3.287
70	1.508	0.942	2.363	3.840
80	1.723	1.077	2.706	4.394
90	1.939	1.212	3.048	4.947
100	2.154	1.346	3.391	5.501
120	2.585	1.615	4.077	6.608
150	3.231	2.019	5.105	8.269
180	3.877	2.423	6.133	9.930
200	4.308	2.692	6.819	11.037
250	5.385	3.365	8.533	13.804
300	6.462	4.039	10.246	16.572

4:3 Perspective				
Screen Size	Width(H)	Height(V)	Wide	Tele
30	0.610	0.457	0.970	1.590
40	0.813	0.610	1.305	2.132
60	1.219	0.914	1.976	3.216
70	1.422	1.067	2.312	3.757
80	1.626	1.219	2.647	4.299
90	1.829	1.372	2.982	4.841
100	2.032	1.524	3.318	5.382
120	2.438	1.829	3.989	6.466
150	3.048	2.286	4.995	8.091
180	3.658	2.743	6.001	9.716
200	4.064	3.048	6.672	10.799
250	5.080	3.810	8.349	13.508
300	6.096	4.572	10.026	16.216

Projection distance formula

16:9	Screen size	WIDE	=	36.4874	*	Projection distance	+	1.3276
		TELE		22.5925				0.7819
16:10	Screen size	WIDE	=	29.1750	*	Projection distance	+	1.0615
		TELE		18.0648				0.6252
4:3	Screen size	WIDE	=	29.8139	*	Projection distance	+	1.0848
		TELE		18.4604				0.6389

Projection Screen Size Unit: inch

Projection Distance Unit: m

Installation

16:9 Perspective				
Screen Size	Width(H)	Height(V)	Wide	Tele
30	0.664	0.374	0.699	1.153
40	0.886	0.498	0.942	1.547
60	1.328	0.747	1.428	2.336
70	1.550	0.872	1.671	2.729
80	1.771	0.996	1.914	3.124
90	1.992	1.121	2.157	3.518
100	2.214	1.245	2.400	3.912
120	2.657	1.494	2.886	4.700
150	3.321	1.868	3.614	5.882
180	3.985	2.241	4.343	7.065
200	4.428	2.491	4.829	7.853
250	5.535	3.113	6.043	9.823
300	6.641	3.736	7.258	11.794

16:10 Perspective				
Screen Size	Width(H)	Height(V)	Wide	Tele
30	0.646	0.404	0.758	1.249
40	0.862	0.538	1.021	1.675
60	1.292	0.808	1.576	2.527
70	1.508	0.942	1.838	2.953
80	1.723	1.077	2.101	3.379
90	1.939	1.212	2.364	3.805
100	2.154	1.346	2.626	4.231
120	2.585	1.615	3.151	5.083
150	3.231	2.019	3.939	6.361
180	3.877	2.423	4.727	7.640
200	4.308	2.692	5.252	8.492
250	5.385	3.365	6.565	10.622
300	6.462	4.039	7.878	12.752

4:3 Perspective				
Screen Size	Width(H)	Height(V)	Wide	Tele
30	0.610	0.457	0.862	1.418
40	0.813	0.610	1.159	1.900
60	1.219	0.914	1.754	2.865
70	1.422	1.067	2.051	3.347
80	1.626	1.219	2.349	3.829
90	1.829	1.372	2.646	4.312
100	2.032	1.524	2.943	4.794
120	2.438	1.829	3.538	5.759
150	3.048	2.286	4.430	7.206
180	3.658	2.743	5.322	8.653
200	4.064	3.048	5.916	9.617
250	5.080	3.810	7.403	12.029
300	6.096	4.572	8.889	14.441

Projection distance formula

16:9	Screen size	WIDE	=	41.1664	*	Projection distance	+	1.2247
		TELE		25.3753				0.7422
16:10	Screen size	WIDE	=	37.7220	*	Projection distance	+	1.4041
		TELE		23.4711				0.6885
4:3	Screen size	WIDE	=	33.6359	*	Projection distance	+	1.0016
		TELE		20.7328				0.6082

Projection Screen Size Unit: inch

Projection Distance Unit: m

Installation

Lens shift adjustment

With the manual lens shift function, you can move the projection lens left, right and up, and it can enable us to easily adjust the image position.

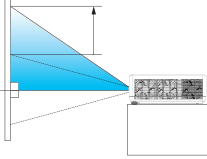
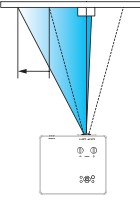
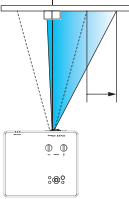
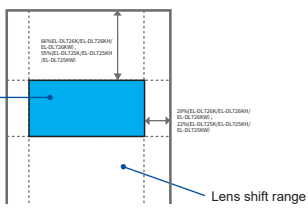
<p>The projection location of your image may be moved upward a distance up to 60% of distance image. But downward adjustment cannot be shifted.</p>	<p>Move lens to it top position</p> 
<p>The projection location of your image may be moved leftward a distance up to 29% of the width of the image.</p>	<p>Move lens to it leftmost position</p> 
<p>The projection location of your image may be moved rightward a distance up to 29% of the width of the image.</p>	<p>Move lens to it rightmost position</p> 
<p>Scope of lens shift adjustment (when the lens move to the limit, the screen will be dark or shadow)</p>	 <p>Center the lens</p> <p>Lens shift range</p> <p> <small> 60% (EL-DL720K/EL-DL720H) EL-DL720H/EL-DL720K 29% (EL-DL720K/EL-DL720H) EL-DL720H/EL-DL720K </small> </p> <p> <small> 29% (EL-DL720K/EL-DL720H) EL-DL720H/EL-DL720K 29% (EL-DL720K/EL-DL720H) EL-DL720H/EL-DL720K </small> </p>



- This table is measured with standard lens.
- When the setting of LENS SHIFT as the maximum position, the corner of projection image might be darker.

Connect to pc (Digital and Analog RGB)

Cables for connection:

LAN cable*

Serial cable (Cross type)*

HDMI cable

(* This cable is not included.)



Note

- Unplug power cords of your projector and all external equipment before connecting any cables to them.

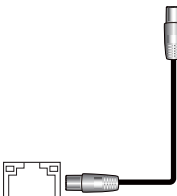
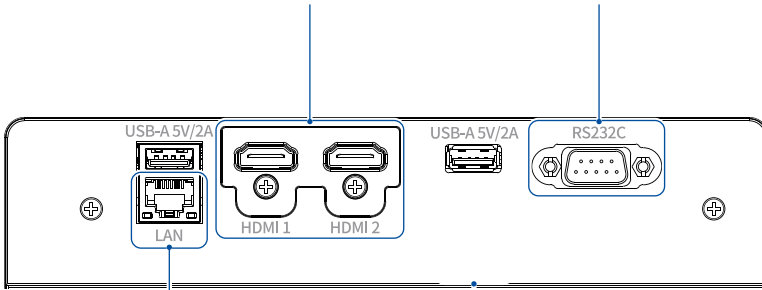
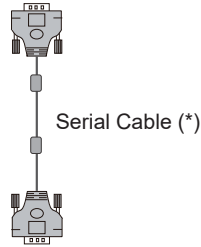
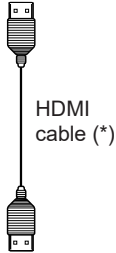

LAN

Installation

Connect the AC power cord

Standard voltage employed by your projector is AC 100-240V. It adapts to different input voltage automatically. Your projector employs single-phase power cord with neutral ground cable. DO NOT use any other type of power cords or you may face the risks of electric shock. In case you have any doubt on type of power cord you are using, please call authorized dealer or service center for help. Before powering on your projector, get all external equipment connected in advance.



Note

- Keep your AC power socket close to your projector for easy plugging and unplugging.

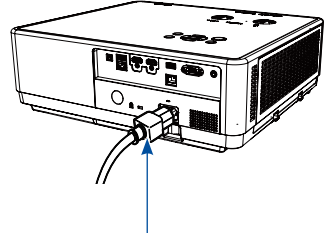

Connect included AC power cord to your projector.

✓ Note:

For safety reasons, unplug the AC power cord when your projector is not in use. Your projector will consume a small amount of power when it is connected to AC grid power and in standby mode.

Precautions on power cord

Your AC power cord should meet regulations of the country/district where your projector is used. Please make sure the type of the power plug is compliant with those given in figure below. Make sure you are using a valid AC power cord. In case the included AC power cord does not comply with the AC power socket in your location, call your dealer for replacement.

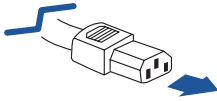
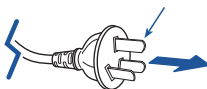
The projector side	Connect to the AC power socket
 <p data-bbox="240 1056 498 1109">Connect to power cord connector of your projector</p>	<p data-bbox="722 949 868 973">Grounding end</p>  <p data-bbox="828 1050 968 1101">Connect to AC power socket</p>

✓ Note:

- For safety reasons, unplug the AC power cord when your projector is not in use. Your projector will consume a small amount of power when it is connected to AC grid power and in standby mode.
- Use of invalid power cord may hamper product performance or even lead to electric shock, fire, and other incidents. Please use power cord compliant with the included one to ensure product performance and operation safety.
- The frequently used cables are: AC power cord, HDMI cable, video cable, and serial control cable.

Menu item overview

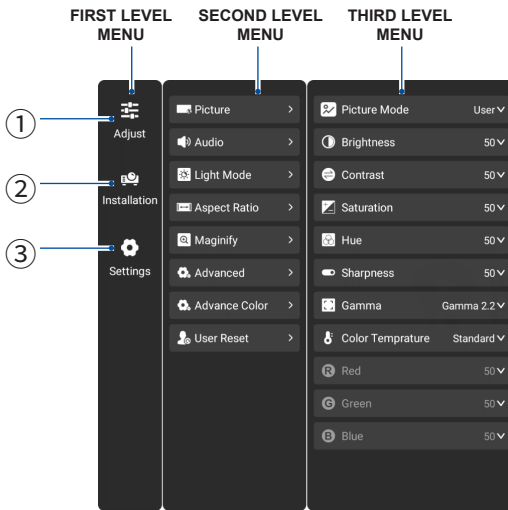

1. Adjust menu

Picture: Picture Mode, Brightness, Contrast, Saturation, Hue, Sharpness, Gamma, Color Temperature, Red, Green, Blue.

Light Mode: Light Mode

Aspect Ratio: Aspect Ratio

Magnify: Zoom Ratio, Positions

Advanced: HDMI Range, HDMI EDID

Advance Color: Hue, Saturation, Luminance

User Reset

2. Installation menu

Orientation: Orientation

Geometric Correction: Keystone, Cornerstone

Filter Maintain: Filter Lifetime, Warning Message, Used Time

High Altitude: High Altitude

Digital Shift: Digital Shift

3. Setting menu

General: Language

LAN: DHCP

Power Management: Power On Mode, Standby Mode, Auto Power Off

HDMI Setting: HDMI CEC, HDMI ARC

About...: Firmware Version, MCU Version, Model name, Resolution, Internet MAC Address, Optical and mechanical service time

Firmware Upgrade: Local Update, Network Update

Pjinfo

Factory Reset

Basic operation

Adjusting the picture size and position

Use the lens shift button, the adjustable foot, the zoom lever/zoom ring and the focus ring to adjust the picture size and position.

In this chapter drawings and cables are omitted for clarity.

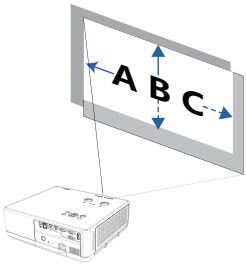
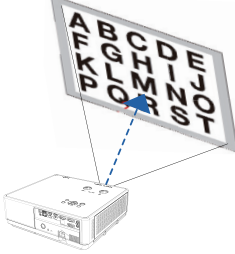
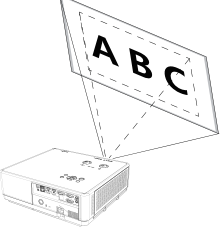
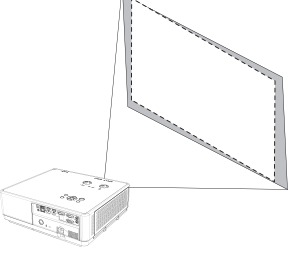
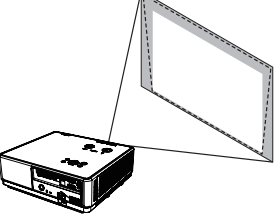
Adjusting the projected image's vertical and horizontal position [Lens shift]	Adjusting the focus [Focus ring]
	
Finely adjusting the size of an image [Zoom lever]	Adjusting the projected image's height and horizontal tilt [Adjustment pad]
	
Correcting the keystone distortion [Keystone]	
	

Lens shift function

Press the ① and ② button to make lens shift adjustment manually.

Rotate ① button, and you can move upward by a distance up to 66% of the image. (See Figure three for detail)

Rotate ② button, and you can move rightward and leftward by a distance up to 29% of the width of the image. (See Figure four for detail)

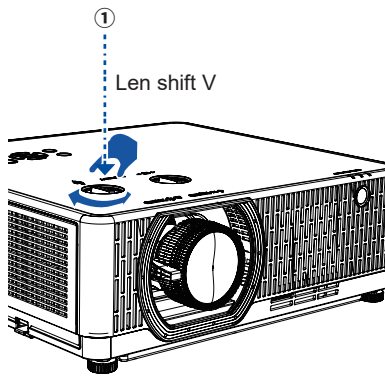

Image 1

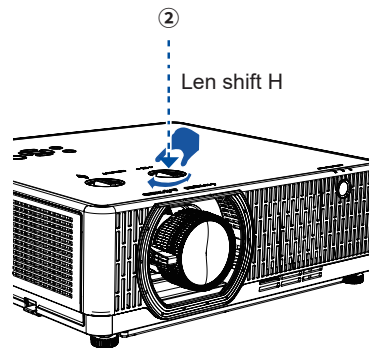

Image 2

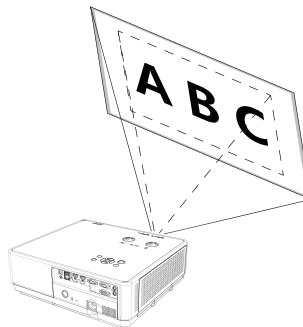

Image 3

✓ Note:

- The button can be turned more than one full turn, but the projection position cannot be moved more than the range indicated on the following page. Do not force to turn the button. Doing so may damage the button.
- If the lens is shifted to the maximum in the diagonal direction, the edges of the screen will be dark or shaded.
- The vertical shift adjustment must be finished with an image shifted upward. If you finish the vertical shift adjustment with an image shifted down, the zoom/focus adjustments or strong shaking may cause a projected image to slightly shift down.

Basic operation

Focus adjustment

Use the focus ring to obtain the best focus.

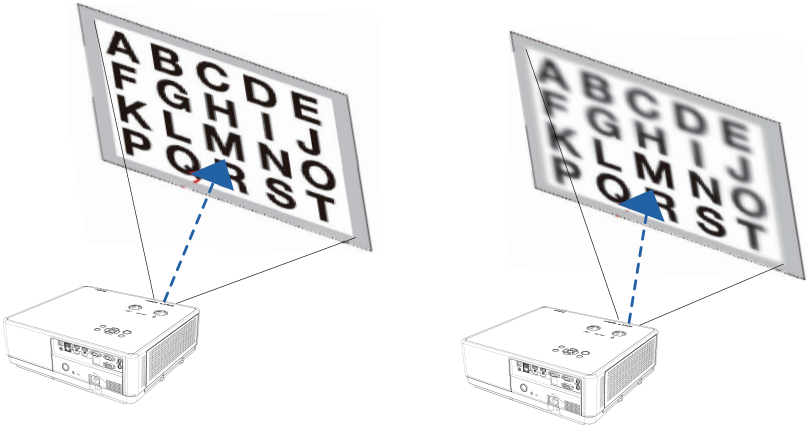
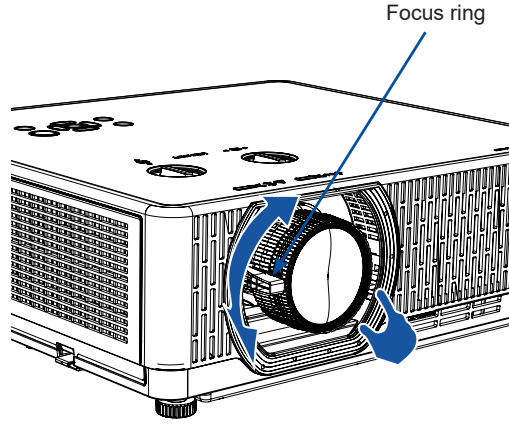

Zoom adjustment

Turn the zoom lever clockwise and counterclockwise.

Zoom lever

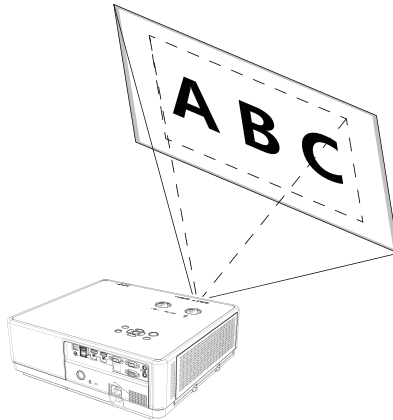
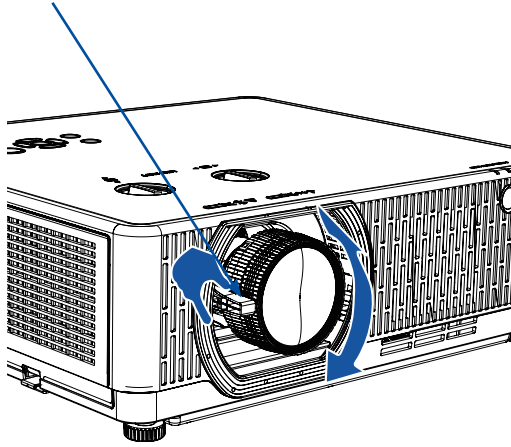

Basic operation

Adjustment pad

Adjusting the left and right tilt.

1. Place the projector perpendicular to the screen.
2. Turn the left and right tilt feet to adjust.
 - You may use the adjustment pad to raise your projector up to 1.0 degree, just show as below Image (1).
 - Rotate the adjustable pad and tilt the projector to the required height whose max height is up to 18mm, just show as below Image (2).
 - Turn the pad to tilt your projector to required height, just show as below Image (3). Turn both pads clockwise to raise your projector, while turn both pads counterclockwise to lower down your projector or close the pad.

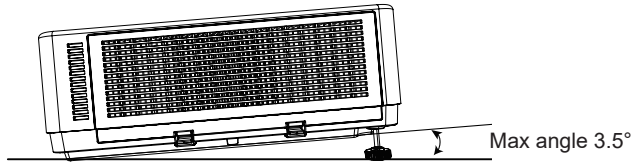

Image (1)

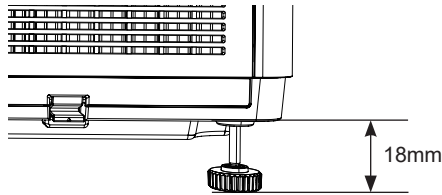

Image (2)

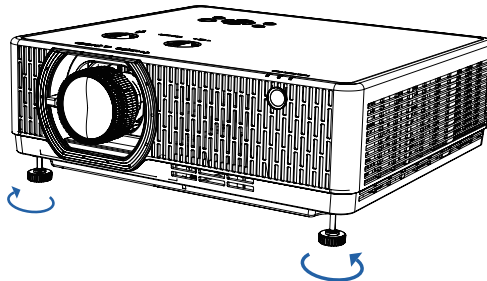

Image (3)

Remote control operation

Use your remote control for common operations.

KEYSTONE

Press the KEYSTONE button on the remote control to select the desired trapezoidal correction mode to correct the image image.

SIZE

Press the SIZE button on the remote control to select the desired screen ratio.

PICTURE

Press the PICTURE button on the remote control to select the desired image mode.

ZOOM+/-

Press the Zoom+/- buttons on the remote control. The screen menu disappears and displays digital zoom+information. Press the Zoom+/- keys to zoom in or out on the image.

Press the ◀◀▶▶▲ buttons to pan the image.

Panning is only effective when the image size is greater than the screen size.

FREEZE

Press the FREEZE button on the remote control, the image remains still and the audio is in a mute state. The still icon appears during screen rest. To deactivate the still function, press the FREEZE key again to replay the image and restore the audio to sound.

ECO

Press the ECO button on the remote control to select the desired light source mode.

BLANK

Press the BLANK button on remote control; a blank screen displays to replace existing image. Press the BLANK button or any other button to restore the image.

Press the BLANK to toggle switch your screen as shown below:

BLANK → Normal → BLANK → Normal →

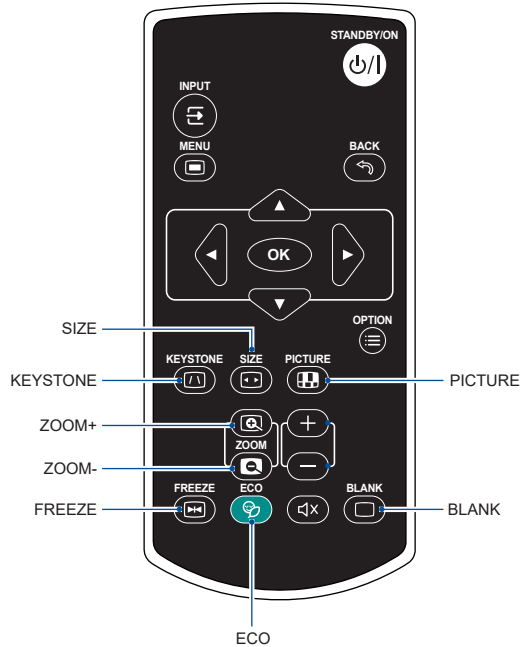

Basic operation

Input selection

Press the "Input" button on the top shell control panel or remote control, and select HDMI1, HDMI 2, or USB as the input source.



HDMI 1

Select input HDMI 1 if a device is connected to the HDMI 1 terminal.

HDMI 2

Select input HDMI 2 if a device is connected to the HDMI 2 terminal.

Basic operation

Adjust Menu

[Picture]

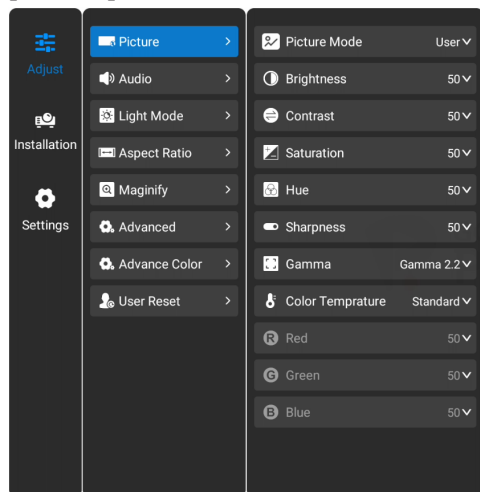

item	option	description
Picture Mode	Standard	The preset normal image mode of this machine can achieve natural color reproduction.
	Soft	By adjusting parameters such as brightness, contrast, and color saturation of the image, the projected image is made softer, more natural, and more comfortable, reducing the stimulation of excessive light and color on the user's eyes.
	Movie	Watching a movie can better reproduce the visual effects and color representations designed by the filmmakers.
	Sport	Playing fast moving or action scenes can better present clear, smooth, and detailed images.
	Game	Optimize the brightness, contrast, color representation, and response speed of the image. It can provide better image quality and visual experience in the game.
	User	The image mode preset by the user in the image adjustment menu.
Brightness ^{*1}	0~100	Adjust the brightness of the projection screen.
Contrast ^{*1}	0~100	Adjust the contrast of the projection screen.
Saturation ^{*1}	0~100	Adjust the saturation of the projection image.
Hue ^{*1}	0~100	Adjust the chromaticity of the projection screen.

item	option	description
Sharpness ^{*1}	0~100	Adjust the sharpness of the projection image.
Gamma	Gamma 1.6	Make the projected image clearer, brighter, and fuller.
	Gamma 1.8	
	Gamma 2.0	
	Gamma 2.2	
	Gamma 2.4	
	Gamma 2.6	
Color Temperature	Standard	Adjust the projected image to a balanced tone.
	Warm	Adjust the projected image to a warm color tone.
	Cool	Adjust the projected image to a cool color tone.
	User	Customize and adjust the color tone of the screen.
Red ^{*2}	0~100	Adjust the red tone of the projection screen.
Green ^{*2}	0~100	Adjust the green tone of the projection screen.
Blue ^{*2}	0~100	Adjust the blue tone of the projection screen.

*1 Adjustable when the image mode is "user".

*2 Adjustable when the color temperature option is "user".

Basic operation

[Light Mode]

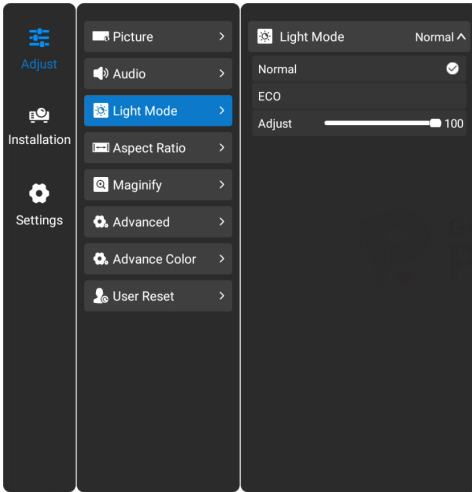

item	option	description
Light Mode	Normal	Factory default light source brightness.
	Eco	By reducing brightness, the cooling fan will also correspondingly reduce energy consumption and extend the service life of the light source.
	Adjust	Manually adjust the brightness of the light source to achieve a comfortable visual effect.

[Aspect Ratio]

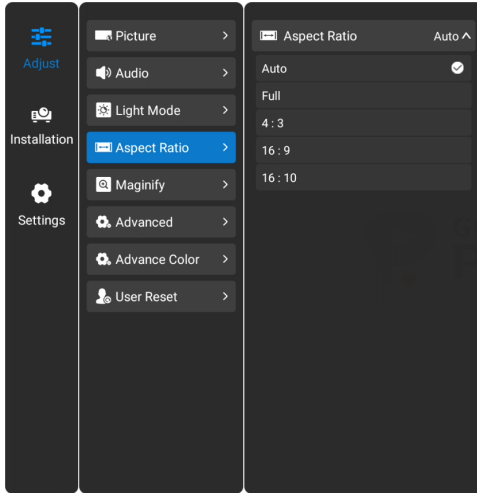

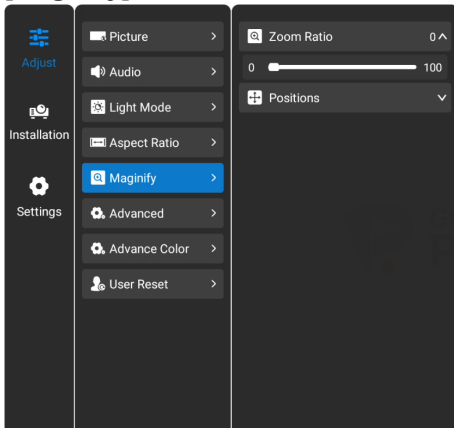

item	option	description
Aspect Ratio	Auto	Automatically recognize the proportion of the input signal source image and project the image at its maximum size.
	Full	Project images with screen maximization.
	4:3	Project the image with a 4:3 aspect ratio.
	16:9	Project the image with a 16:9 aspect ratio.
	16:10	Project the image with a 16:10 aspect ratio.

[Maginify]

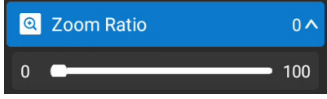

Basic operation

item	option	description	picture
Zoom Ratio	0~100	Enlarge the image scale of the screen. Use the ◀▶ button on the top control panel or remote control to make adjustments.	
Positions	Enter	Pan the enlarged image to the display area. Make adjustments using the ▲▼◀▶ button on the top control panel or remote control.	

[Advanced]

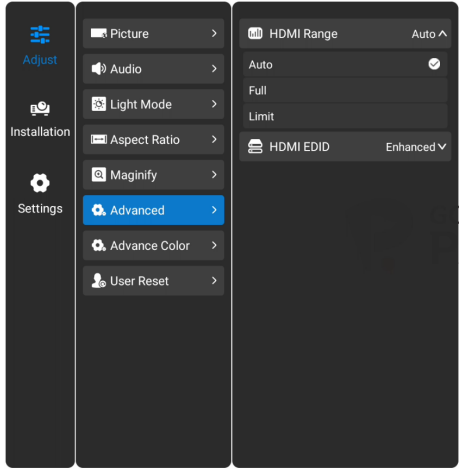

item	option	description
HDMI Range	Auto	In this mode, the source device will determine the most suitable dynamic range based on the received display device's EDID information. The EDID information will indicate whether the dynamic range supported by the display device is Standard Dynamic Range (SDR) or Extended Dynamic Range (HDR). The source device will automatically select the corresponding dynamic range and send appropriate video signals to ensure optimal image quality and compatibility. This mode is usually suitable for most regular HDMI connections.

item	option	description
HDMI Range	Full	In this mode, the source device will set the output signal to Extended Dynamic Range (HDR), regardless of whether the connected display device supports it or not. This can provide a higher color depth and contrast range to achieve richer and more realistic image effects. However, if the display device does not support extended dynamic range, there may be situations where the image is too bright or distorted.
	Limit	In this mode, the source device will set the output signal to the standard dynamic range (SDR), regardless of whether the connected display device supports extended dynamic range. This can ensure that the image can be displayed normally on various display devices, but it may lose some dynamic range and image details.
HDMI EDID	Auto	In this mode, the source device will dynamically read and adapt to the EDID information of the connected display device. Based on the EDID data of the display device, the source device automatically selects the optimal resolution, refresh rate, and other parameters to ensure optimal image quality and compatibility. This mode is suitable for most conventional HDMI connections and can automatically adapt to various display devices.
	Enhanced	In this mode, the source device will preload a specific EDID file and set it using the fixed parameters in the file. Regardless of the EDID information of the actual connected display device, the source device will output using preset parameters. This mode is suitable for scenarios with special needs, such as applications that require fixed resolutions or specific color spaces.
	Normal	In this mode, the source device ignores the EDID information of the connected display device and directly sends a fixed default setting. This means that the source device will output signals with fixed parameters, regardless of the actual requirements and capabilities of the display device. This mode is suitable for some special situations, such as old devices or non-standard display devices, which may not be able to read or parse EDID information properly.

Basic operation

[Advance Color]

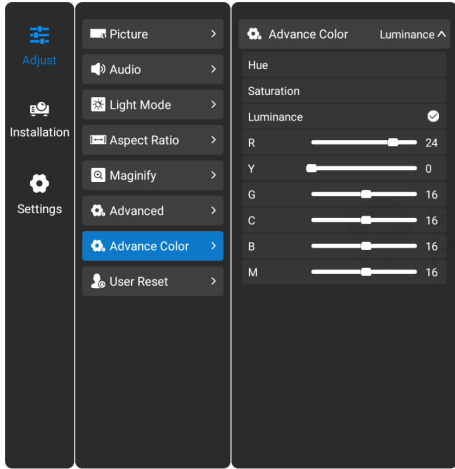

item	option	description
Advance Color	Hue	Adjust the values of R (red), Y (yellow), G (green), C (blue), B (blue), and M (magenta) in the color tones, with an adjustment range of 0-63.
	Saturation	Adjust the saturation values of R (red), Y (yellow), G (green), C (blue), B (blue), and M (magenta) in the range of 0-63.
	Luminance	Adjust the values of R (red), Y (yellow), G (green), C (blue), B (blue), and M (magenta) in the brightness, with an adjustment range of 0-31.

[User Reset]

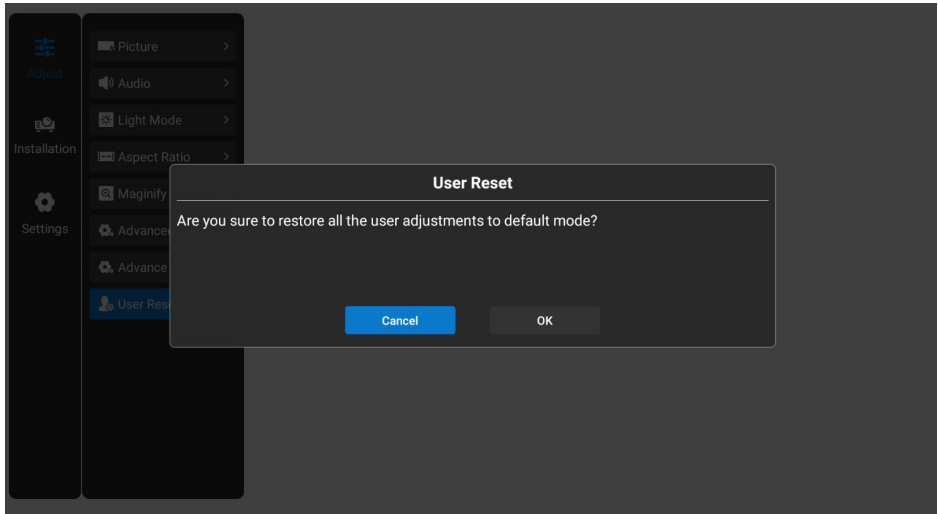

item	description
User Reset	Restore all user adjusted parameter values in the image mode to the default mode.

Basic operation

Installation Menu

[Orientation]

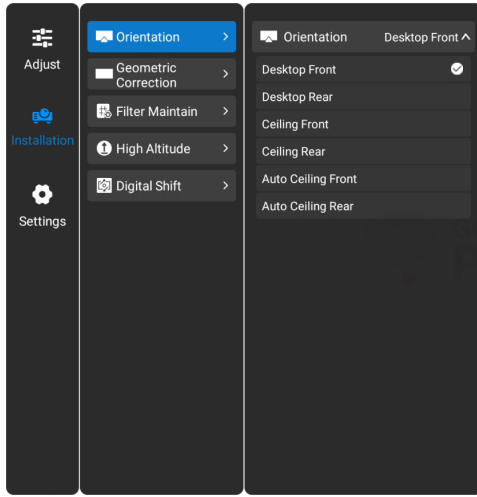

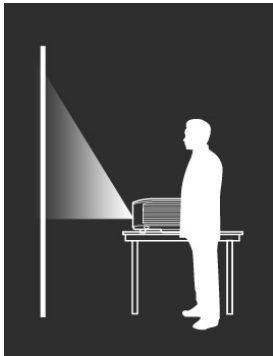
item	option	description	picture
Orientation	Desktop Front	When installing the projector on the table and projecting from the front of the screen.	

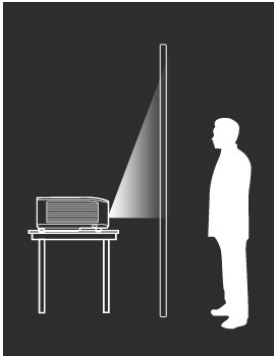
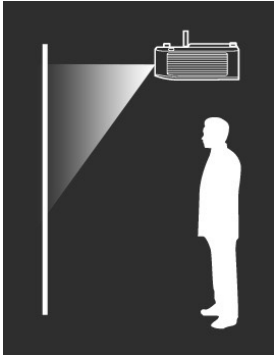
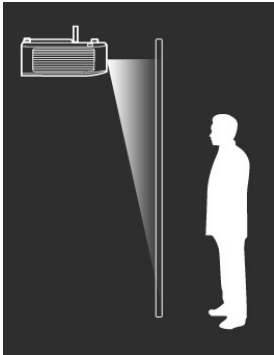
item	option	description	picture
Orientation	Desktop Rear	When installing a projector on a table and projecting from behind the screen (using a semi transparent screen).	
	Ceiling Front	When using a projector lifting bracket (optional) to install the projector in front of the screen.	
	Ceiling Rear	When using a projector lifting bracket (optional) to install the projector behind the screen (using a semi transparent screen).	

Basic operation

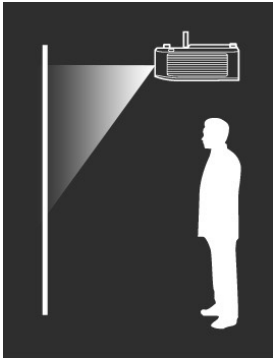
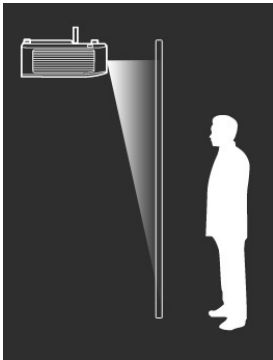
item	option	description	picture
Orientation	Auto Ceiling Front	When using a projector lifting bracket (optional) to install the projector in front of the screen.	
	Auto Ceiling Rear	When using a projector lifting bracket (optional) to install the projector behind the screen (using a semi transparent screen).	

[Geometric Correction]

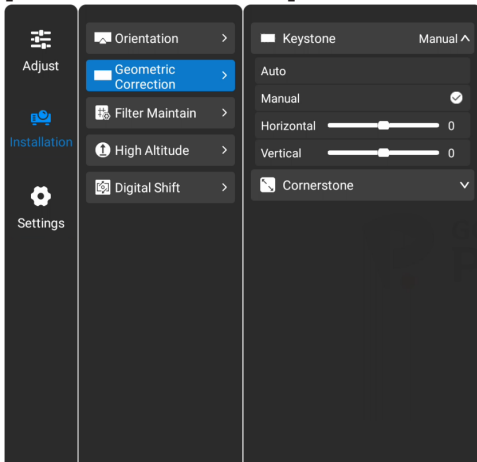

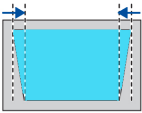
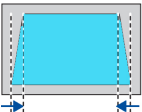
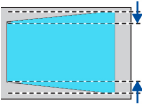
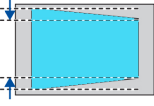
item	option	description	picture
Keystone	Auto	Automatically correct projection images.	-
	Manual	Manually correct the horizontal/vertical direction of the projection image.	<p>When the vertical correction value is negative, the left and right vertical lines at the bottom of the screen contract towards the center.</p> 
			<p>When the vertical correction value is positive, the left and right vertical lines at the top of the screen contract towards the center.</p> 
			<p>When the horizontal correction value is negative, the horizontal line at the top and bottom of the left side of the screen contracts towards the center.</p> 
<p>When the horizontal correction value is positive, the horizontal line at the top and bottom of the right side of the screen contracts towards the center.</p> 			

Basic operation

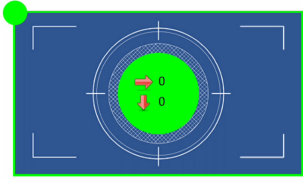
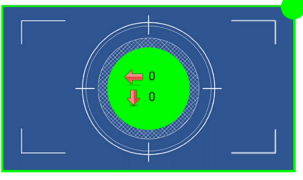
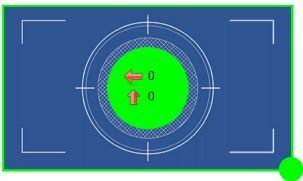
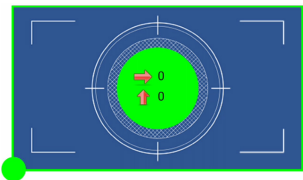
item	option	description	picture
Cornerstone	Enter	<p>Correct the upper left corner of the projection screen and press the control panel or remote control ▲▼◀▶ button to make adjustments. *Note: When the value is 0, only the ▶ and ▼ buttons are valid.</p>	
		<p>Correct the upper right corner of the projection screen and press the control panel or remote control ▲▼◀▶ button to make adjustments. *Note: When the value is 0, only the ◀ and ▼ buttons are valid.</p>	
		<p>Correct the bottom right corner of the projection screen and press the control panel or remote control ▲▼◀▶ button to make adjustments. *Note: When the value is 0, only the ◀ and ▲ buttons are valid.</p>	
		<p>Correct the bottom left corner of the projection screen and press the ▲▼◀▶ button on the body control panel or remote control to make adjustments. *Note: When the value is 0, only the ▶ and ▲ buttons are valid.</p>	

[Filter Maintain]

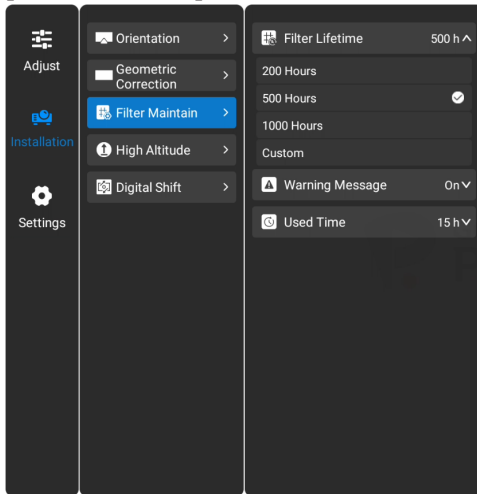

item	option	description
Filter Lifetime	200 Hours	The projector will display maintenance information after 200 hours of use of the filter.
	500 Hours	The projector will display maintenance information after 500 hours of use of the filter.
	1000 Hours	The projector will display maintenance information after 1000 hours of use of the filter.
	Custom	The projector will display maintenance information after the filter is used for a specified period of time.
Warning Message	Off	When the projector reaches the user set cleaning time, no information is displayed on the screen.
	On	When the projector reaches the user set cleaning time, a filter warning message will be displayed on the screen.
Used Time	xx Hours Used	Display the time the projector filter has been in use.
	Used Time	Reset the usage time of the projector filter.

Basic operation

[Filter Maintain]

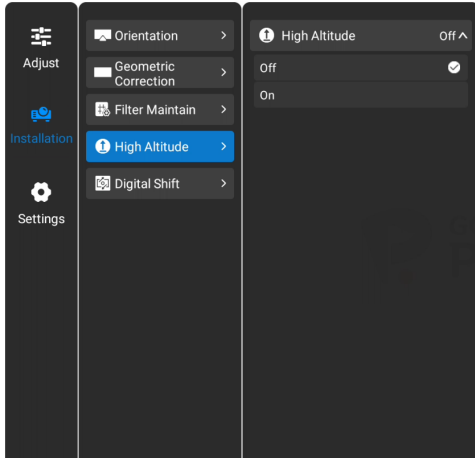

item	option	description
High Altitude	Off	Turn off high altitude mode when the altitude of the area is below 1700m.
	On	The altitude of the area is between 1700 and 3000m, and the high altitude mode is activated.

[Digital Shift]

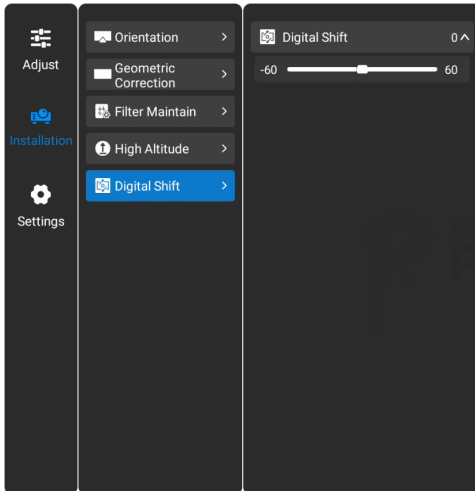

Basic operation

item	option	description
Digital Shift	-60~60	Translate the projection image vertically, with negative numbers moving upwards and positive numbers moving downwards.

Basic operation

Settings Menu

[General]

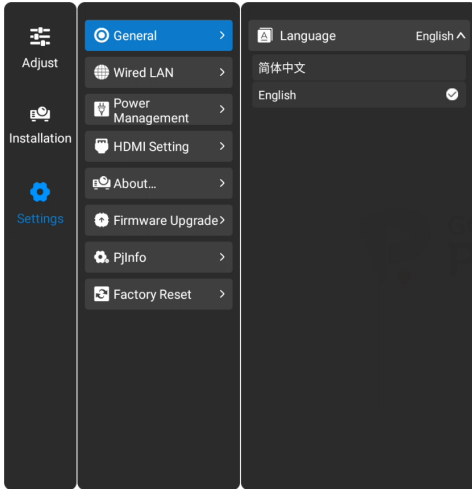

item	option	description
Language	简体中文	Set the projector language to Simplified Chinese.
	English	Set the projector language to English.

[Wired LAN]

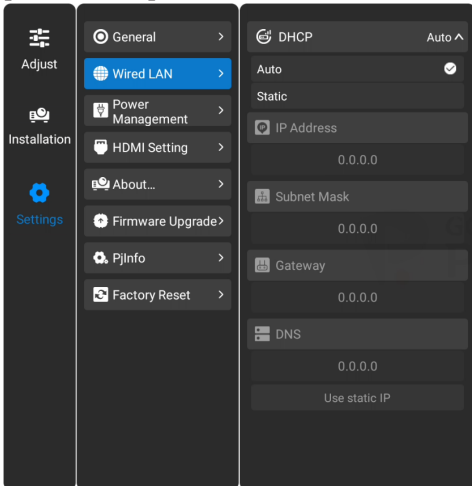

item	option	description
DHCP	Auto	The projector automatically obtains the IP address after inserting the network cable.
	Static	Manually set the IP address.

[Power Management]

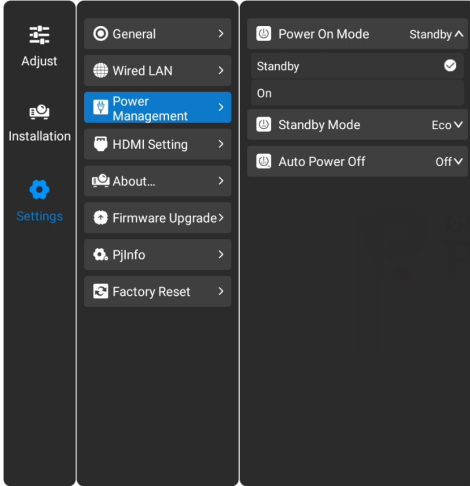

item	option	description
Power On Mode	Standby	The projector enters standby mode after connecting to the power cord.
	On	The projector enters the power on state after connecting to the power cord.
Standby Mode	Eco	Reduce standby power consumption and extend the lifespan of the projector.
	Normal	Normal standby mode.
Auto Power Off	Off	Turn off the projector's "Auto Power Off" function.
	15 Minutes	The projector will automatically shut down in 15 minutes.
	30 Minutes	The projector will automatically shut down in 30 minutes.
	60 Minutes	The projector will automatically shut down in 60 minutes.
	120 Minutes	The projector will automatically shut down in 20 minutes.
	Custom	Set the projector to automatically shut down after a specified amount of time.

Basic operation

[HDMI Setting]

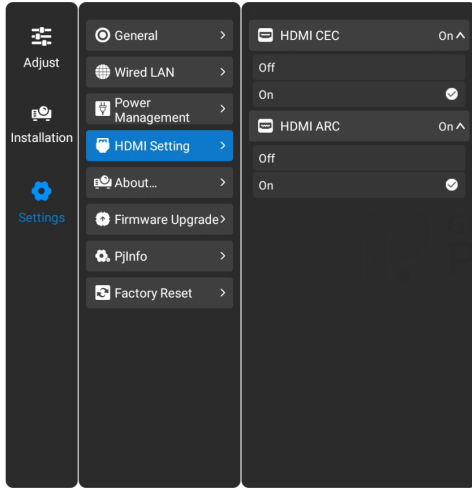

item	option	description
HDMI CEC	Off	Interconnection and control of input/output devices are not allowed.
	On	Allow input/output devices to be interconnected and controlled.
HDMI ARC	Off	Turn off HDMI audio echo function.
	On	Enable HDMI audio echo function. Output audio signals to power amplifiers/audio devices through HDMI.

✓ **Note :**

- HDMI ARC is only available when HDMI CEC is turned on.

[About...]

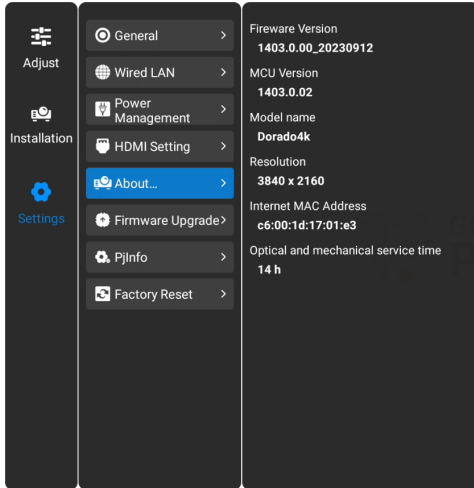

item	description
Fireware Version	Display the projector firmware version number.
MCU Version	Display the projector MCU version number.
Model name	Display the projector model.
Resolution	Display projector display resolution.
Internet MAC Address	Display the Ethernet MAC address connected to the projector.
Optical and mechanical service time	Display the usage time of the projector light machine.

[Firmware Upgrade]

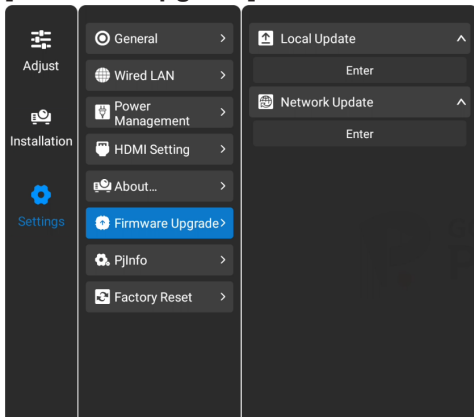

Basic operation

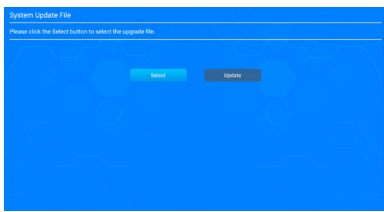
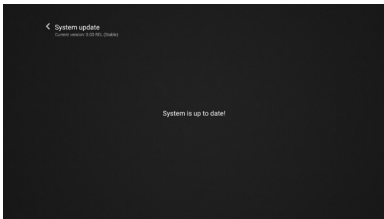
item	option	description	picture
Local Update	Enter	Use the USB flash drive to select the upgrade package for local firmware upgrade.	
Network Update	Enter	When the projector has a new version of firmware that needs to be updated, enter the network upgrade interface to upgrade the firmware online.	

✓ **Note :**

- If there is no new firmware upgrade required, the screen will display "System is up to date!".

[Pjinfo]

PJ-InforTranToDevice

Basic Information

User Name	user address
recipient	123@net.com.abc@net.com
CC Email	123@net.com.abc@net.com

Model information

Brand	DREAMVISION	Model	Dorado4k
Lamp Counter	9	S/N	c6001d1701e3
Fireware Version	1.403.0.00_20230912	MCU Version	1.403.0.02
		Filter Counter	10
		Resolution	3840x2160

SAVE
EXIT

item	option	description
Pjinfo	Enter	Enter recipient and email information, and then save. After the projector reports an error, it will automatically send the error code to the recipient via email.

[Factory Reset]

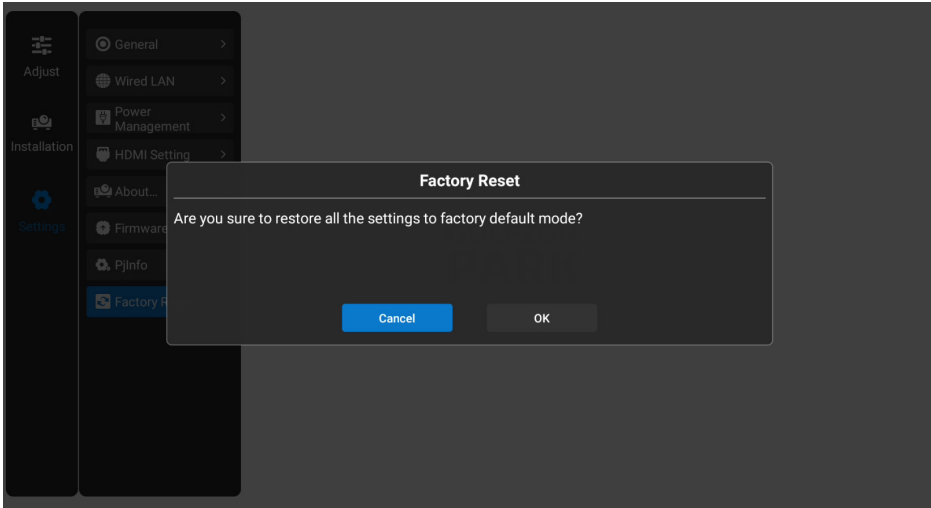

item	description
Factory Reset	Restore all settings and restore the projector to the factory default mode.

Maintenance and cleaning

Clean the projector when contaminated by foreign matter or its display effects are getting worse.



Note:

Unplug the AC power cord before any cleaning operation.

Clean casing of your projector

Gently wipe the casing with clean and soft cloth dampened with small amount of neutral detergent to remove heavy dirt. Do not over apply cleaner to the casing. Abrasive cleaner, solution, or other rough chemical may scratch the casing surface.

Place your projector in proper container after use to protect it from dirt and dust and being scratched.

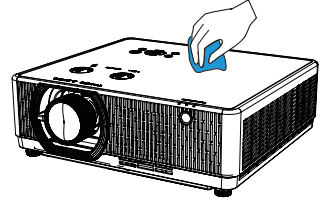

Clean the lens

Wipe the lens with clean cloth dampened with non-abrasive camera lens cleaner or clean it with lens cleaning paper or air blower.

Do not over apply cleaner to the lens. Abrasive cleaner, solution, or other rough chemical may scratch the lens.

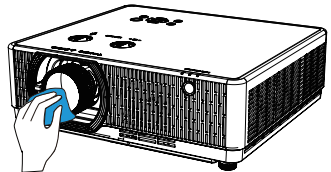

Clear the filter

The filter is designed to keep dust from entering your projector, which may lead to dusts accumulated on surface of internal components. Clogged filter may reduce cooling fan effects, which, in turn, will overheat your projector and shorten its life cycle. Clean the filter immediately whenever the Filter Warning icon displays.

Please follow these steps to clean your filter:

- 1 Power off your projector and unplug from AC power source.
- 2 Remove the filter.
- 3 Gently clean it with a brush.
- 4 Replace the filter. Make sure it has been fully inserted.

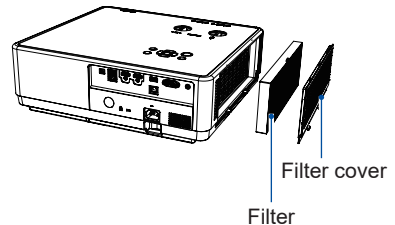

Note:

Do not operate your projector after its filter is removed. Dust may attach to the lens assembly and deteriorate image quality.

Do not insert any small object in the air outlet. It may fail your projector.

Troubleshooting

Check the following before calling your dealer or service center:

Troubleshooting	Solution
Power on failure	<ul style="list-style-type: none"> –Plug the power cord of your projector in an AC socket. –Make sure the POWER light indicator turns orange. –Restart your projector until the POWER light indicator turns orange. It indicates your projector is ready for power on again.
Logo screen display failure	<ul style="list-style-type: none"> –Make sure the Off and Countdown Off is selected in the Display function.
Image looks fuzzy	<ul style="list-style-type: none"> –Adjust focus of your projector. –Provide proper projection distance. –The projection lens requires cleaning. –Moving your projector from a colder environment to a hotter one may result in condensing on the lens. If this is the case, wait until the condensing water evaporated before powering on your projector.
Image mirror reflected Image turns upside down	<ul style="list-style-type: none"> –Check the Ceiling and Rear settings. –Check the Ceiling settings.
Image looks dim	<ul style="list-style-type: none"> –Check for contrast and brightness settings. –Check for correct image mode settings
No image displays	<ul style="list-style-type: none"> –Check for the connection between your projector and computer or image equipment. –Check for correct input signal from computer. Connection with certain notebook computer may mandate changes to its display output settings. See the user manual included with the computer for details on settings. –It takes about 10 seconds for your projector to show the first image. –Check for mode of signal, color system, image system, or computer system. –Make sure the ambient temperature is within given range [0°C–50°C]. –mage does not display in BLANK mode. The BLANK button or other buttons on the remote control.
Abnormal color	<ul style="list-style-type: none"> –Check for mode of signal, color system, image system, or computer system.

Appendix

Some operations are invisible	– Check the display function.
Settings do not save after power off	–Make sure you have selected Store after settings adjustment. Certain settings do not keep without selecting Store.
Power management failure	–In case of Freeze or Blank operation, the power management function does not work.
Image distorted or disappeared	–Check and revise the PC Adj. menu or Screen menu.
Remote control does not work	–Check the battery. –Make sure there is no obstacles stand in between your projector and the remote control. –Make sure the remote control is not too far away from your projector. The maximum operation range is 8m. –Make sure the remote control and your projector are paired with the same remote control codes.
Light indicator turns on or flashes	–Check status of your projector according to the light indicator status.
"X " mark displays	–Invalid operation, please operate your projector correctly.

- Make sure your projector is correctly connected to external equipment.
- Make sure all devices have plugged in an AC power source and have been powered on.
- If your projector fails to project image of the connected computer, restart the computer.



































Note:

































Your projector employs high voltage power for operation. Do not open its casing. If the problem persists, call your dealer or service center. Along with model number of your projector and a description to your problem. You will be advised on getting our services.







Light indicator status

Check light indicator to learn status of your projector.

POWER	STATUS	LIGHT	Projector status
 Off	 Off	 Off	Power is off
 Orange	 Off	 Off	Standby(Normal)
 Orange (Blink* ³)	 Off	 Off	Standby(Network)
 Green	 Off	 Green (Blink* ²)	Light source on (Normal mode)
 Green	 Off	 Green	Light source on (ECO mode)
 Red (Blink* ¹)	 Off	 Off	Cooling
 Red	 Red (Blink* ²)	 Off	PSENSER abnormal (poor contact or temperature out of range)
 Red	 Red (Blink* ⁴)	 Off	TempC Error
 Red	 Orange (Blink* ²)	 Off	Fan 1 error
 Red	 Orange (Blink* ³)	 Off	Fan 2 error
 Red	 Orange (Blink* ⁴)	 Off	Fan 3 error

Appendix

POWER	STATUS	LIGHT	Projector status
 Red	 Orange (Blink* ⁵)	 Off	Fan 4 error
 Red	 Orange (Blink* ⁶)	 Off	Fan 5 error
 Red	 Orange (Blink* ⁷)	 Off	Fan 6 error
 Red	 Red (Blink* ²)	 Orange	Color wheel IO abnormality
 Red	 Red (Blink* ⁴)	 Orange	Color wheel speed too high
 Red	 Red (Blink* ⁵)	 Orange	Color wheel speed too low
 Red	 Red (Blink* ¹)	 Red	LD other abnormalities (cannot be specified)
 Red	 Red (Blink* ²)	 Red	LD current anomaly (overcurrent protection, low current anomaly)
 Red	 Red (Blink* ³)	 Red	LD voltage abnormality (overvoltage protection, low voltage abnormality)
 Red	 Red (Blink* ⁴)	 Red	Abnormal communication
 Red	 Red (Blink* ⁶)	 Red	LD temperature abnormality

POWER	STATUS	LIGHT	Projector status
 Red	 Red (Blink*7)	 Red	LD status abnormal
 Red	 Red	 Off	High altitude error

*1 on for 0.5 seconds, off for 0.5 seconds

*2 Flashes once and turns off for 2 seconds

*3 Flashes twice and turns off for 2 seconds

*4 Flashes 3 times and turns off for 2 seconds

*5 Flashes 4 times and turns off for 2 seconds

*6 Flashes 5 times and turns off for 2 seconds

*7 Flashes 6 times and turns off for 2 seconds

Appendix

Compatible computer screen

Your projector is designed to accept every computer signal below Dot Clock 160MHz .
See table below for details on resolution and relevant frequency.



No	OSD Display	Source	Specification			
		HDMI	Resolution	Pixel clock (MHz)	H-freq(KHz)	V-freq(Hz)
1	640X480P_60Hz	○	640X480P	25.200	31.500	60.000
2	720X480P_59.94Hz	○	720X480P	27.000	31.469	59.940
3	720X480P_60Hz	○		27.027	31.500	60.000
4	480I_60Hz	○	720(1440)X480i	27.028	15.750	60.000
5	576_50Hz	○	720(1440)X576i	27.000	15.625	50.000
6	720X576P_50Hz	○	720X576P	27.000	31.250	50.000
7	800×600_60Hz	○	800×600	40.000	37.879	60.320
8	1024×768_60Hz	○	1024×768	65.000	48.363	60.000
9	1280X720P_24Hz	○	1280X720P	59.400	18.000	24.000
10	1280X720P_30Hz	○		74.250	22.500	30.000
11	1280X720P_50Hz	○		74.250	37.500	50.000
12	1280X720P_60Hz	○		74.250	45.000	60.000
13	1920X1080i_50Hz	○	1920X1080i	74.250	28.125	50.000
14	1920x1080i_60hz	○		74.250	33.750	60.000
15	1920X1080P_24Hz	○	1920X1080P	74.250	27.000	24.000
16	1920X1080P_30Hz	○		74.250	28.130	25.000
17	1920X1080P_50Hz	○		148.500	56.250	50.000
18	1920X1080P_60Hz	○		148.500	67.500	60.000
19	1920X1200_60HZ	○	1920X1200	154.000	74.038	59.950
20	3840X2160_24Hz	○	3840X2160P	297.000	54.000	24.000
21	3840X2160_25Hz	○		297.000	56.250	25.000
22	3840X2160_30Hz	○		297.000	67.500	30.000
23	3840X2160_60Hz	○		594.000	135.000	59.940

24	4096X2160_24Hz	○	4096X2160P	297.000	54.000	23.980
25	4096X2160_30Hz	○		297.000	67.500	29.970
26	4096X2160_50Hz	○		594.000	112.500	50.000
27	4096X2160_60Hz	○		594.000	135.000	59.940

✓ **Note:**
“○” Shows input signal source support this format.
“—” Shows input signal source DO NOT support.

Appendix

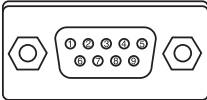
Terminal configuration

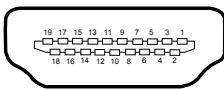
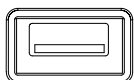
SERIAL Terminal (D-SUB-9)				
	1	-----	6	-----
	2	RXD	7	-----
	3	TXD	8	-----
	4	-----	9	-----
	5	GND		
LAN Terminal				
	1	TX +	5	-----
	2	TX -	6	RX -
	3	RX +	7	-----
	4	-----	8	-----
HDMI Terminal (HDMI Type A 19)				
	1	TMDS Data2+	11	TMDS Clock Shield
	2	TMDS Date2 Shield	12	TMDS Clock-
	3	TMDS Date2-	13	CEC
	4	TMDS Date1+	14	Reserved(N.C. on device)
	5	TMDS Datel Shield	15	SCL
	6	TMDS Datel-	16	SDA
	7	TMDS Date0+	17	DDC/CEC Ground
	8	TMDS Date0 Shield	18	+5V Power
	9	TMDS Date0-	19	Hot Plug Detect
	10	TMDS Clock+		
	1	VBUS	5	-----
	2	D-	6	-----
	3	D+	7	-----
	4	GND	8	-----

Dimensions

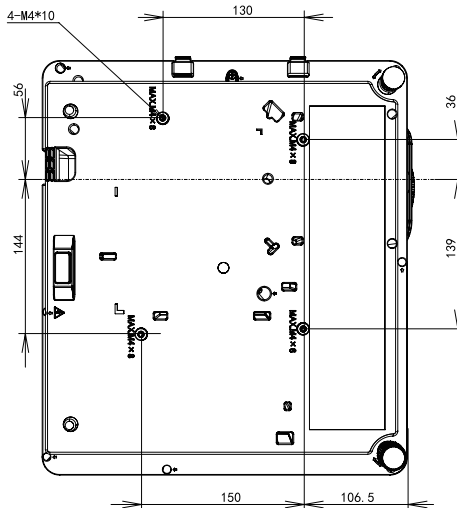
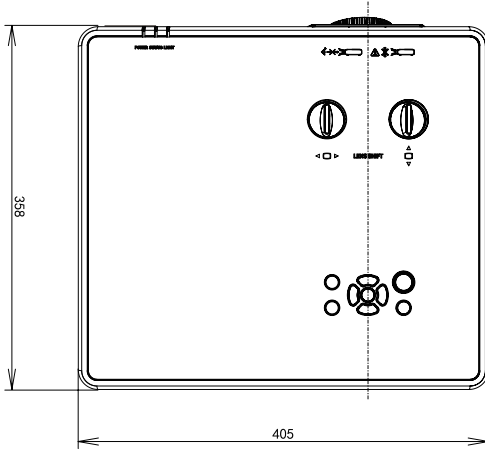
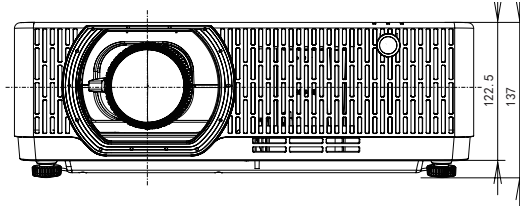

Unit: mm

Screw Holes for Ceiling

Mount(6 pcs)

Screw: M4

Depth: 8.0

Technical Specifications

Mechanical properties

Dimensions (W×D×H):	405mm x358mm x 137mm
Net Weight	7.9 Kg
Adjustable foot	3.5°

LCD resolution

LCD system	0.64"x3 TFT, active matrix
LCD resolution	4K Enhance
Scanning frequency	Horizontal frequency: 15 ~100 KHz; Vertical frequency: 24~85 Hz

Optical elements

Image size (diagonal lines)	30"-298", adjustable
Throw Ratio	1.2 (wide)-2.0(tele)

Projection distance 0.786~13.244m

F 1.5~2.08

f 17.2~27.7mm

Terminal

HDMI*2	HDMI A type 19 pin
LAN	RJ45
USB-A*2	USB connector (A type x1)
RS-232	D-sub 9 pin x1

Power

Voltage and power consumption	4.5A 50/60 Hz 600W (Max) 440W (ECO)
Fuse	10A/250V

Operating Environment

Operating temperature	0°~40°(Altitude1700-3000m) 0°~50°(Altitude 0-1700m)
Operating humidity	20% ~ 85%
Storage Temperature	-10°~50° C
Storage humidity	10% ~ 85%
High land	3000 m
Noise	38dB (Normal) 28dB (ECO) [* The test ambient temperature is 23±2°C , the test standard is ISO 7779:2018]

Remote control

Battery	AAA Alkaline type x 2
Operating Range	±15° About 6 meters, straight line about 8 meters
Dimensions	110mm (L) x 50mm (W) x 20mm (H)
Net Weight	38g

Accessories

Remote control and batteries&AC power cord&HDMI cable

- The specification is subject to change without prior notice.
- Liquid crystal panel is made on the basis of high standard, where 99.99% of the pixels are effective.
- Due to the nature of the liquid crystal panel, a fraction of the pixels (0.01% or less) may be ineffective.

RS232 control mode

Serial connection

1.1 Port setting

Project	Setpoint
Communication method	Asynchronous communication
Communication rate	19200
Length	8-bit
Parity check	NO
Stop position	1
Flow control	NO

1.2 Connection mode

Can only use RS232 serial cross connect PC and projector.

Computer terminal

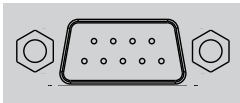

Projector terminal

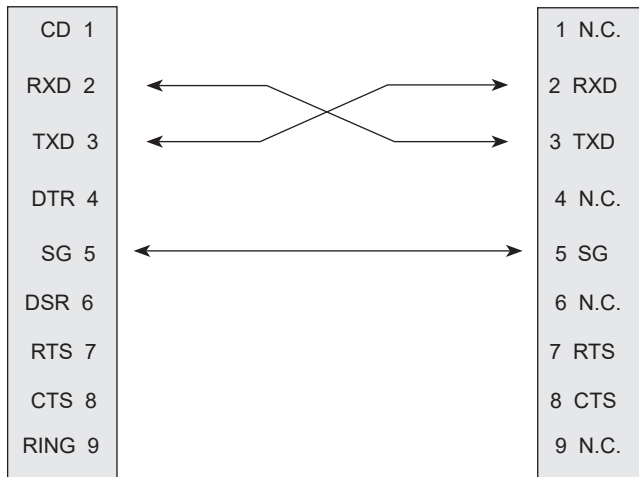
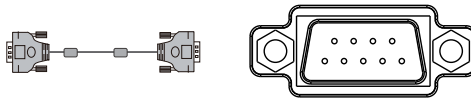

Appendix

2. Basic commands

Distinguish the letter case.and enter Each command ends with [CR] (enter) .

Command	Option
C00	POWER ON
C02	POWER OFF
C36	HDMI 1
C37	HDMI 2
C16	Memory Viewer

2.1 POWER ON command

Command	"C00"[CR]	
Details	Power ON action. Do nothing,when you are in Power ON state . Send this command can force the end of the countdown in the countdown state.	
Return Value	Receive Successfully	[ACK] [CR]
	Receive Unsuccessfully	" ? " [CR]

2.2 POWER OFF command

Command	"C02"[CR]	
Details	Power OFF action. A "POWER OFF " dialog box pops up when sending the POWER OFF command ,and do once again can force your projector to power off. Send this command can force the end of the countdownthe in the countdown state.	
Return Value	Receive Successfully	[ACK] [CR]
	Receive Unsuccessfully	" ? " [CR]

2.3 HDMI 1 command

Command	"C36"[CR]	
Details	Select HDMI1 Input.	
Return Value	Receive Successfully	[ACK] [CR]
	Receive Unsuccessfully	" ? " [CR]

2.4 HDMI 2 command

Command	"C37"[CR]	
Details	Select HDMI2 Input.	
Return Value	Receive Successfully	[ACK] [CR]
	Receive Unsuccessfully	" ? " [CR]

2.5 Memory Viewer command

Command	"C16"[CR]	
Details	Select Memory Viewer Input .	
Return Value	Receive Successfully	[ACK] [CR]
	Receive Unsuccessfully	" ? " [CR]

Trademarks

- MultiPresenter is a trademark or registered trademark of NEC Display Solutions, Ltd. in Japan and other countries.
- Apple, Mac, MacBook, and iMac are trademarks of Apple Inc. registered in the U.S. and other countries.
- Microsoft, Windows, and PowerPoint are either a registered trademark or trademark of Microsoft Corporation in the United States and/or other countries.
- The terms HDMI and HDMI High-Definition Multimedia Interface, and the HDMI Logo are trademarks or registered trademarks of HDMI Licensing Administrator, Inc. in the United States and other countries.



- Blu-ray is a trademark of Blu-ray Disc Association
- CRESTRON and CRESTRON ROOMVIEW are trademarks or registered trademarks of Crestron Electronics, Inc. in the United States and other countries.
- Extron and XTP are registered trademarks of RGB Systems, Inc. in the United States.
- Ethernet is either a registered trademark or trademark of Fuji Xerox Co., Ltd.
- Other product names and company logos mentioned in this his user's manual may be the trademarks or registered trademarks of their respective holders.